

IoT Based Smart Security and Safety System for Women and Children

T.Navaneetha R.Nivetha, K.Mithun sugadev

Department of ECE, Sri Krishna college of technology, Coimbatore, India

ABSTRACT: Now a days , women and children are facing various issues like sexual assaults. Such violence will definitely have huge impact on the lives of victim . It also affect their health and their psychological balance. These kind of violence keep on increasing day by day. Even school children are kidnapped and sexually abused . We are living in a society where a nine months old girl child doesn't have security, the child was kidnapped, raped and then murdered. On witnessing those violations against women, it impulses us to do something for women and children safety . So, in this project we have planned to propose a device which will act as a tool to provide security and ensures the safety of the women and the children .Microcontroller , GSM and GPS module are used to send notifications and current location of women to various mobile numbers in their contact. In addition, this project will also acts as a safety measure which will stun the opposition for few seconds. This project will help us to rescue many women and children from those fiendish in the society.

KEYWORDS: GSM,GPS,ELECTRIC SHOCK.

I. INTRODUCTION

Safety of women in India has become a major issuenow..According to the National Crime Records Bureau, in 2016 the sexual harassment is increased by 82% compared with the previous years. Across all cases, 95% of rapists were not strangers but family, friends and neighbours.In the wake of recent rape and murder of young women ,much of the public speak about it has been confined to outrage,punishment and tougher laws.Each and every day women and children are being abused or molested around the world.It is necessary to safeguard women from those predators. Laws alone will not protect her from every situation,she have to defend herself.For that a self defence device is needed. Fig 1 shows the record cases of child rapes in India.

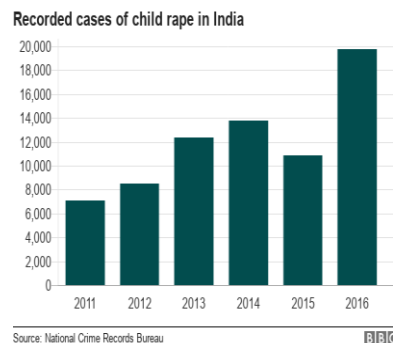

II. LITERATURE SURVEY

ShaistaKhanam, Trupti Shah [1] proposed algorithm for women safety using fingerprint module. This paper gives a detailed approach towards women safety.Here fingerprint is required for activation of device,electric shock producing circuit,GSM and GPS module for alerting and location tracking.At the time of emergency it is hard to place the finger in the fingerprint

module and recognition is not possible,if there is any undesired stuff(wet or dust) in the finger.To avoid this problems the fingerprint module will not be used in the proposed system.

Naeemul Islam, Md.Anisuzzaman, Sikder Sunbeam Islam,MohammedRabiulHossain, AbuJafar Mohammad Obaidullah[2] developed a device for safety and protection of women.Here three push buttons are implemented to define the types of accident victim is facing.To control a whole system a PIC16F887A microcontroller is used.Since it is a 40 pin IC,it increases the size of the device,which will make it difficult for women/children to carry all the time.

SharifaRaniaMahmud,JannatulMaowa,FerryWahyuWibowo[3] proposed an algorithm for women empowerment.This paper discuss about violence against women and also different health issues of women.It is an application based system.During the event of molestation using the application present in the victim’s smartphone will automatically send out an emergency call to the assigned contacts.This can done only when GPS is enabled in the smartphone and if not the time delay taken to turn on the GPS is noted to be the downside of the project.

AnandJatti, MadhviKannan , Alisha RM,Vijayalakshmi P, ShresthaSinha[4] developed a wearable device,which uses physiological signals like galvanic skin resistance and body temperature.Data is monitored using cloud platform and analysed using MATLAB simultaneously.If there is any sudden change in the physiological parameter intimation will be sent to the parents.But body teperature may also change due to some other reasons.So it is not fair to consider body temperature as a parameter to design a device for women safety.

Sunil K Punjabi,SuvarnaChaur, UjwalaRavale, Deepti Reddy[5] developed an intelligent system for women and children.In this system they are using a pressure switch. When they feel unsafe she has to compress the switch, then an intimation will be sent to parents followed by a call. If it is unanswered the call will be redirected to nearby police station.

M.Kavitha, V.Sivachidambaranathan [6] proposed a devie for women self protection using IoT. In this system there are few bio sensors are used to sense the user’s bodily changes. If there is any abnormalities detected on women an intimation will be sent to guardian as per pre program of the device.

R.Pavithra,S.Karthikeyan[7] developed a survey on womens safety mobile application. This application helps women to discover and help them in any critical situations. It helps finds out the exact area of the individual and send SMS to the parents.

MadhuraMahajan, KTV Reddy, ManitaRajput[8] designed a rescue system for safety of women. It is a simpler safety solution that can be achieved by pressing a switch and instantly send out alerts to the near ones of the individual.

NanditaViswanath,Naga Vaishnavi Pakyala, G.Muneeswari[9] developed a samart foot device for women safety.This smart device will be clipped to the footwear of the user.If the foot has been tapped behind the others on four times, an alert will be sent through Bluetooth.

III.COMPONENTS

A.MICROCONTROLLER

Generally microcontrollers are used to interface various peripherals in the circuit. Arduino Uno is a microcontroller which has ATmega 328.The key features of Uno board are Pinout,Stronger reset circuit and ATmega 16U2 replace the 8U2.

PARAMETER	VALUE
Microcontroller	ATmega 328
Operating voltage	5v
Flash memory	32KB
SRAM	2KB
Clock speed	16MHz
Digital I/O pins	14
Analog input pins	6

TABLE I. SPECIFICATION OF ARDUINO UNO

B.CAPACITIVE TOUCH SENSOR

Capacitive touch sensors are generally used in devices like mobile phones ad MP3 players,they are also found in home appliances and industrial applications.The key features of capacitive touch sensor are robustness,cost,product design and durability.

C.GLOBAL SYSTEM FOR MOBILES

Interaction between computer and the system is enabled by GSM/GPRS. GPRS is nothing but extension of GSM which has high data transmission rate.There are different type of GSM modules are available,we are using SIM 900 GSM.

D.GLOBAL POSITIONING SYSTEM

GPS is used to determine the receiver’s position such as latitude,longitude and altitude. Change in receiver position is lso determined with more accuracy and the velocity also determined.

IV.SYSTEM DESCRIPTION

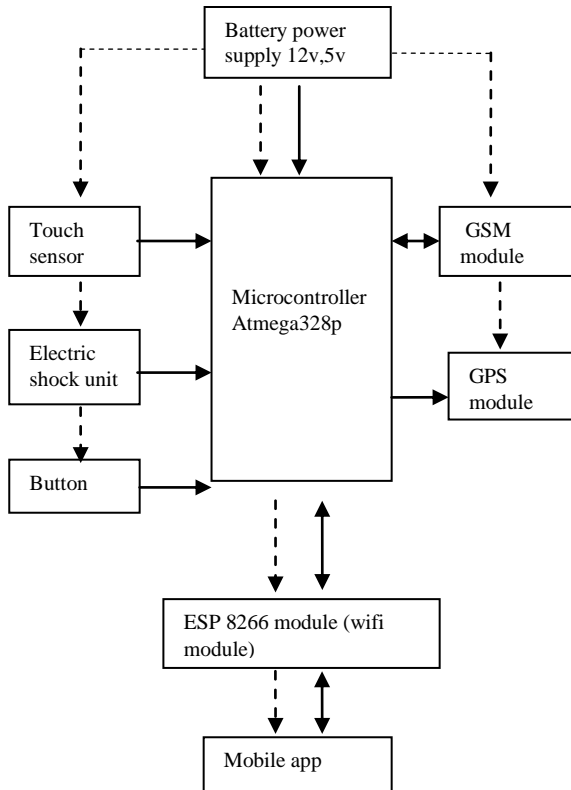

Fig. 1. BLOCK DIAGRAM OFIoT BASED SMART SECURITY AND SAFETY SYSTEM FOR WOMEN AND CHILDREN.

The ultimate aim of the project is to develop a self defencedevice.Whenever there is an emergency, she has to press the button.Then the electric shock unit and the touch sensor gets activated. The High voltage Low current shock circuit will stun the opposition for few seconds,which acts as a self defence. An intimation along with the location will be sent to the contact mobile numbers of the person.

Fig. 1 shows the block diagram of IoT based smart security and safety system for women and children .Microcontroller,Arduinouno is used for interfacing with peripherals. SIM 900 GSM and GPS are used to send notification

along with location. Electric shock circuit is used to generate high voltage low current to paralyse the opponent for few seconds.

A. Interfacing of GSM module with Arduino

Eventhough there are different types of GSM modules are available, we are using a SIM 900 GSM module. Only three connections are required between GSM module and Arduino to interface GSM with Arduino. Different types of output is taken from the PCB board, and it is connected with the GSM module. TTL output is for Arduino and RS232 output is for interfacing directly with the PC. For our project we are choosing an Arduino compatible GSM module with TTL output provisions.

B. High voltage Low current electric shock circuit

The High voltage circuit works on the principle of blocking oscillator concept is shown in Fig.2. R1 and C1 is mainly used for determining the frequency of oscillation. While adjusting the preset the transistor will never come within the unsafe zone, it is ensured by R1. 3V DC power supply is required to operate the circuit. When power supply is given, the center tapped transformer and transistor starts oscillating at high frequency as specified before. This makes the battery current to pass across the TR1 winding. Because of switching, a high voltage is induced across the secondary winding of TR1, which is around 200V. Then the voltage is raised to the appropriate level, such that it will generate a flying spark, which is done by a charge pump circuit used at the output of TR1. This network raises the output voltage from 200V to 600V. The bridge rectifier will rectify the high voltage and stepped up by 2uF/1KV capacitor. When the terminals are relatively close a flying spark will be generated.

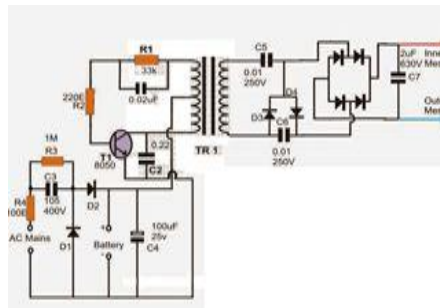

Fig.2. High voltage Low current circuit

V. SYSTEM DESIGN

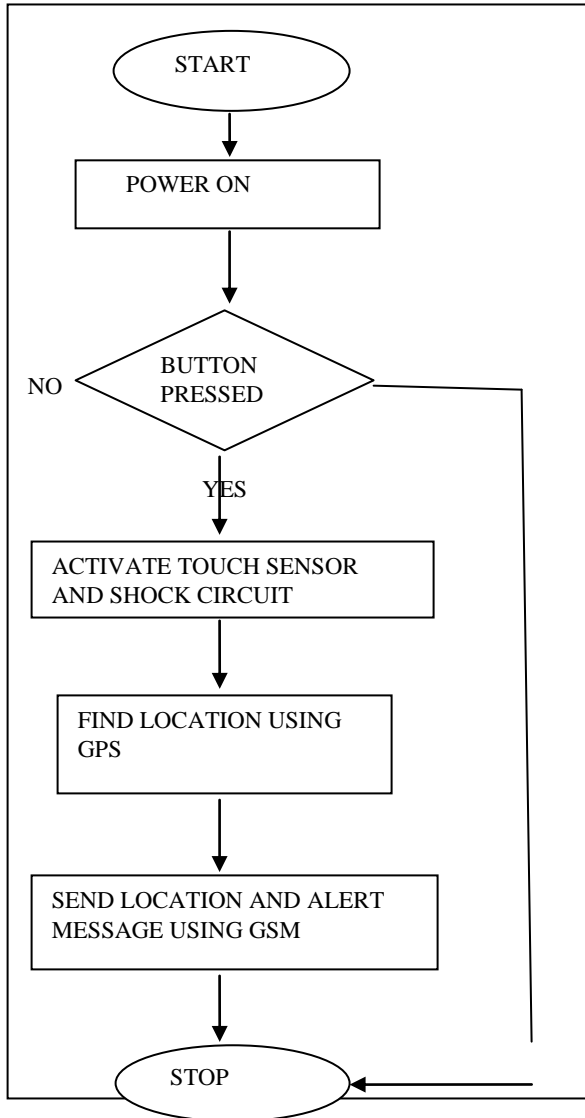

Fig.3. Flowchart of operation of device.

VI. RESULT

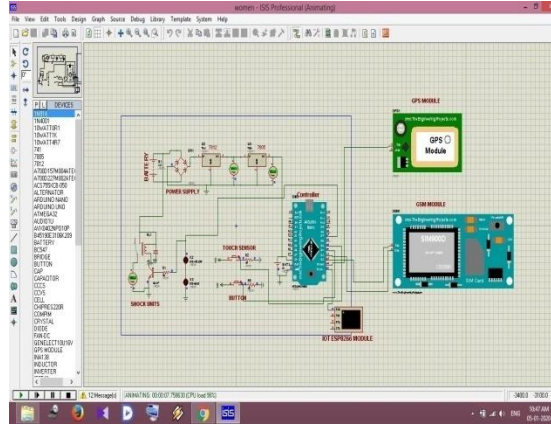

Fig.4. Simulation environment of the system.

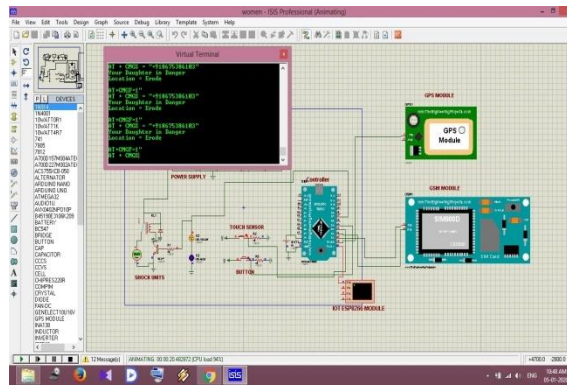

Fig.5.Operation of touch sensor.

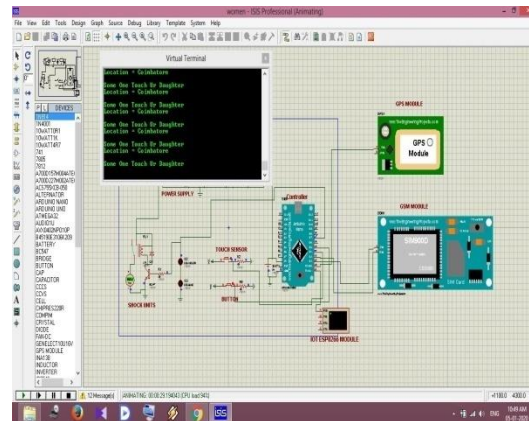

Fig.6. Operation of button.

VII. SUMMARY

Nowadays not only women but children also get molested. In order to provide security and to ensure their safety a system has been proposed in this paper. Many researchers have been working in this area and have developed different

technologies. Using these technologies a selfdefence device is proposed in this paper by adding new feature thereby making it more secure. This paper describe the basic design concept and functionality along with the expected outcomes.

REFERENCES

- [1]ShaistaKhanam, TruptiShah,`SelfDefence Device with GSM alert and GPS tracking with fingerprint verification for women safety`,International conference on electronics communication and aerospace technology[ICECA 2019].
- [2].NaeemulIslam,Md.Anisuzzaman,Sikder Sunbeam Islam,MohammedRabiulHossain,AbuJafar Mohammad Obaidullah, “ Design and Implementation of Women Auspice System by Utilizing GPS and GSM”, International conference on electrical,computer and communication engineering(ECCE),7-9 February,2019.
- [3].SharifaRaniaMahmud,JannatulMaowa,FerryWahyuWibowo,”Women Empowerment: One Stop Solution for Women”,International conferences on information technology , information systems and electrical engineering(ICITISEE),2017.
- [4].AnandJatti, MadhviKannan , Alisha RM, Vijayalakshmi P, ShresthaSinha, “ Design and Development of an IOT based wearable device for the Safety and Security ofwomen and girl children”, International Conference On Recent Trends In Electronics Information Communication Technology, May 20-21, 2016.
- [5].Sunil K Punjabi,SuvarnaChaur, UjwalaRavale, DeeptiReddy,”Smart Intelligent System for Women and Child Security”.
- [6]. M.Kavitha, V.Sivachidambaranathan` Womenself protecting system using Internet of things`. International conference on computational intelligence and computing research, 13-15 Dec 2018.
- [7]. R.Pavithra,S.Karthikeyan ` Survey on womens safety mobile app development`. International conference on Innovations in Information Embedded and Communication systems,17-18 March 2017.
- [8]. MadhuraMahajan, KTV Reddy, ManitaRajput `Design and implementation of rescue system for safety of women`. International conference on Wireless communications, Signal processing and networking, 23-25 March 2016.
- [9].NanditaViswanath, Naga VaishnaviPakyala, G.Muneeswari `samart foot device for women safety` IEEE region ten symposium, 9-11 May 2016.